

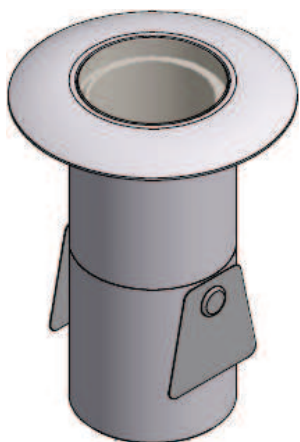







Marker



-  Anodised
-  IP 67
-  Smart 3 channel drive 350 mA
-  Mono: X-leds 350/700 mA
RGB: 12/24/48 V DC
-  Mono: 1 x 2.5 W
RGB: 1 x 3.25 W
-  Smart 3 channel drive 700 mA
-  D: 37 mm
H: 90 mm

Option: Putter Floor recessed box
Order Number: 015040000
(See Accessories)

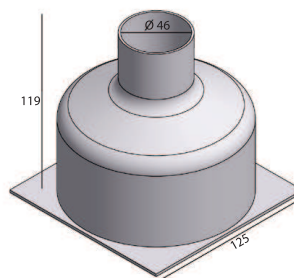

 RJ45 connector
Standard for RGB devices

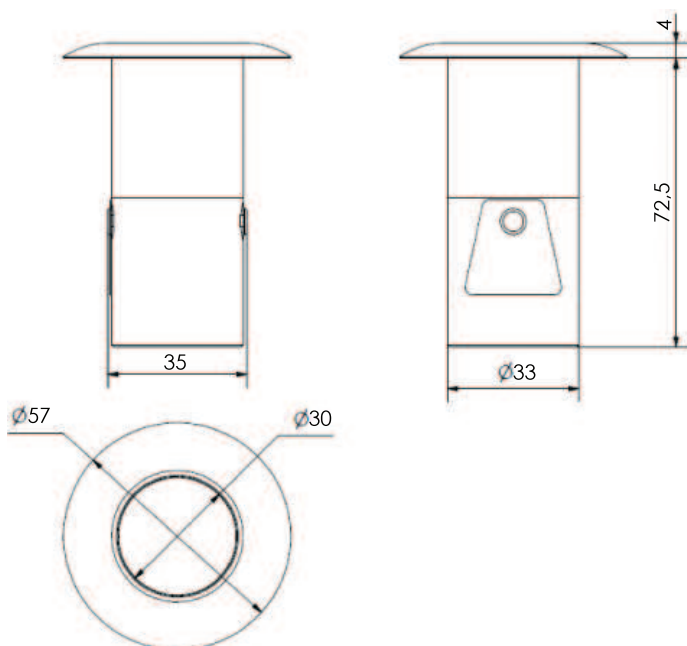

Colour Beam Angle	Temp.	Red	Green	Blue	Amber	3000 K	4000 K	6300 K	RGB
120°		576571222	576571322	576571522	576571622	576575222	576575322	576575822	576572122